

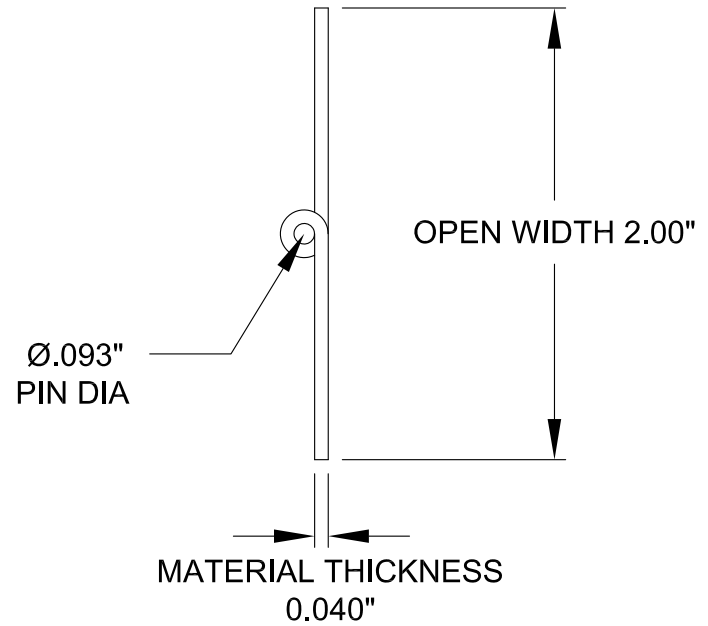

NOTES

- BLANK ALUMINUM CONTINUOUS HINGE



APPROVED BY	 JEFCO MFG INC FT. LAUDERDALE PH 954-527-4220 WWW.JEFCOMFG.COM	MATERIAL: ALUMINUM	MATERIAL ALLOY: 5005	FINISH: MILL	DATE: 01/25/2023	DWG BY: AG
SIGN		REVISIONS:	TOLERANCES: <small>STANDARD DIE CUT EDGES. ALL DIMENSIONS TO BE HELD TO ±.015". NOTE ALL PRODUCTS ARE QUOTED USING STANDARD MILL GAGE MATERIAL. DO NOT SCALE</small>	DESC: A-40200-093-5 X 72" B		
PRINT		COMPANY: JEFCO MFG INC			NO: 10004	